

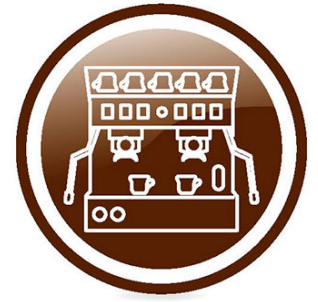

Spare parts for the professional sector:
Espresso coffee machines



Suitable for:

BRUGNETTI-AURORA



This catalogue is automatically generated.
Therefore, the sequence of the items might
not be always shown at best.
Updates will be issued in case of additions
and/or amendments.
Suitable universal spare parts may not be included





BREW GROUP OLD TYPE

OLD TYPE

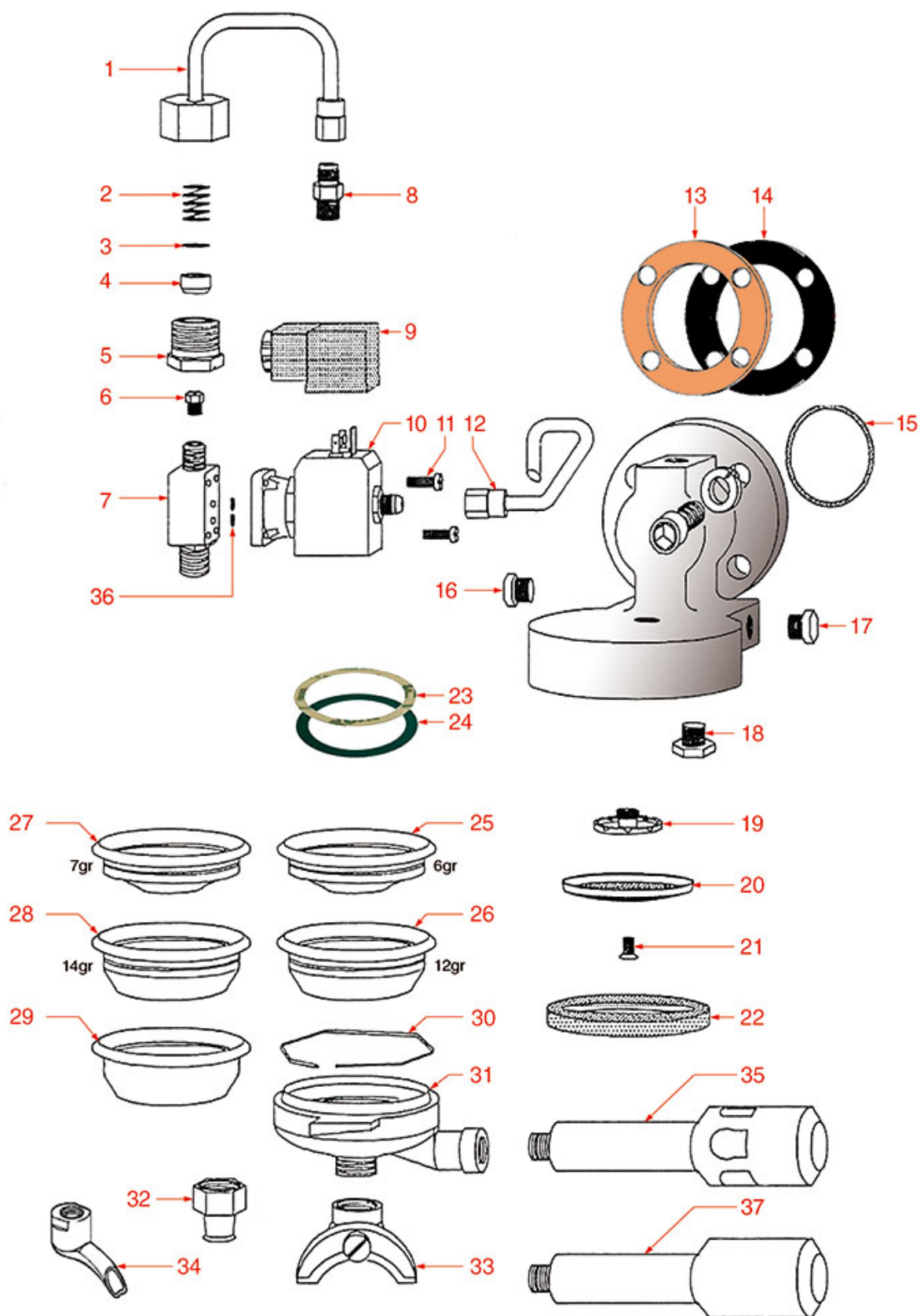

AU0101



BRUGNETTI-AURORA



Position	LF code no.	Description
3	1160516	WATER FILTER ø 11 mm
4	1160515	FILTER HOLDER BUSHING
6	1501541	NOZZLE M6x1 HOLE ø 0,8 mm
9	3120034	CONNECTOR LARGE F-FITTING
10	1120101	3-WAY SOLENOID VALVE PARKER 115V 50/60Hz
10	1120102	3-WAY SOLENOID VALVE LUCIFER 115V 60Hz
10	1120330	3-WAY SOLENOID VALVE LUCIFER 240V 50Hz
10	1120335	3-WAY SOLENOID VALVE PARKER 230V 50/60Hz
11	1455034	CYLINDER HEAD SCREW M4x10
13	1186015	COFFEE GROUP GASKET ø 78x42x2 mm
14	1186098	COFFEE GROUP GASKET ø 78x43x2 mm
15	1186466	O-RING 03181 EPDM
19	1501014	BREW GROUP SPRAY NOZZLE ø 30 mm M9.6x1
20	1081026	SHOWER ø 56.5 mm
22	1186711	FILTER HOLDER GASKET ø 72x56x9 mm
23	1190011	PAPER SEAL ø 72x58x0.8 mm
24	1190003	RUBBER SHIM ø 70x57x1 mm EPDM
25	1160251	1 CUP FILTER 6 g ø 70x20.5 mm
26	1160252	FILTER 2-CUP 12 g ø 70x21 mm
27	1160335	1 CUP FILTER 7 g ø 70x24,5 mm
28	1160337	FILTER 2-CUP 14 g ø 70x24,5 mm
29	1160339	BLIND FILTER ø 70x17 mm
30	1250101	FILTER LOCKING SPRING ø 1,00 mm INOX
31	1165022	FILTER HOLDER FOR COFFEE MACHINES
32	1022503	SPOUT 1 CUP STRAIGHT ø 3/8"
33	1022502	DOUBLE SPOUT ø 3/8"
34	1022501	SPOUT 1 CUP ø 3/8"
35	1241067	FILTER HOLDER HANDLE M12
36	1186611	O-RING 02025 RED SILICONE
36	1186612	O-RING 02025 VITON
37	1241501	FILTER HOLDER HANDLE M12
37	1241504	FILTER HOLDER HANDLE M12



BREW GROUP NEW TYPE

NEW TYPE

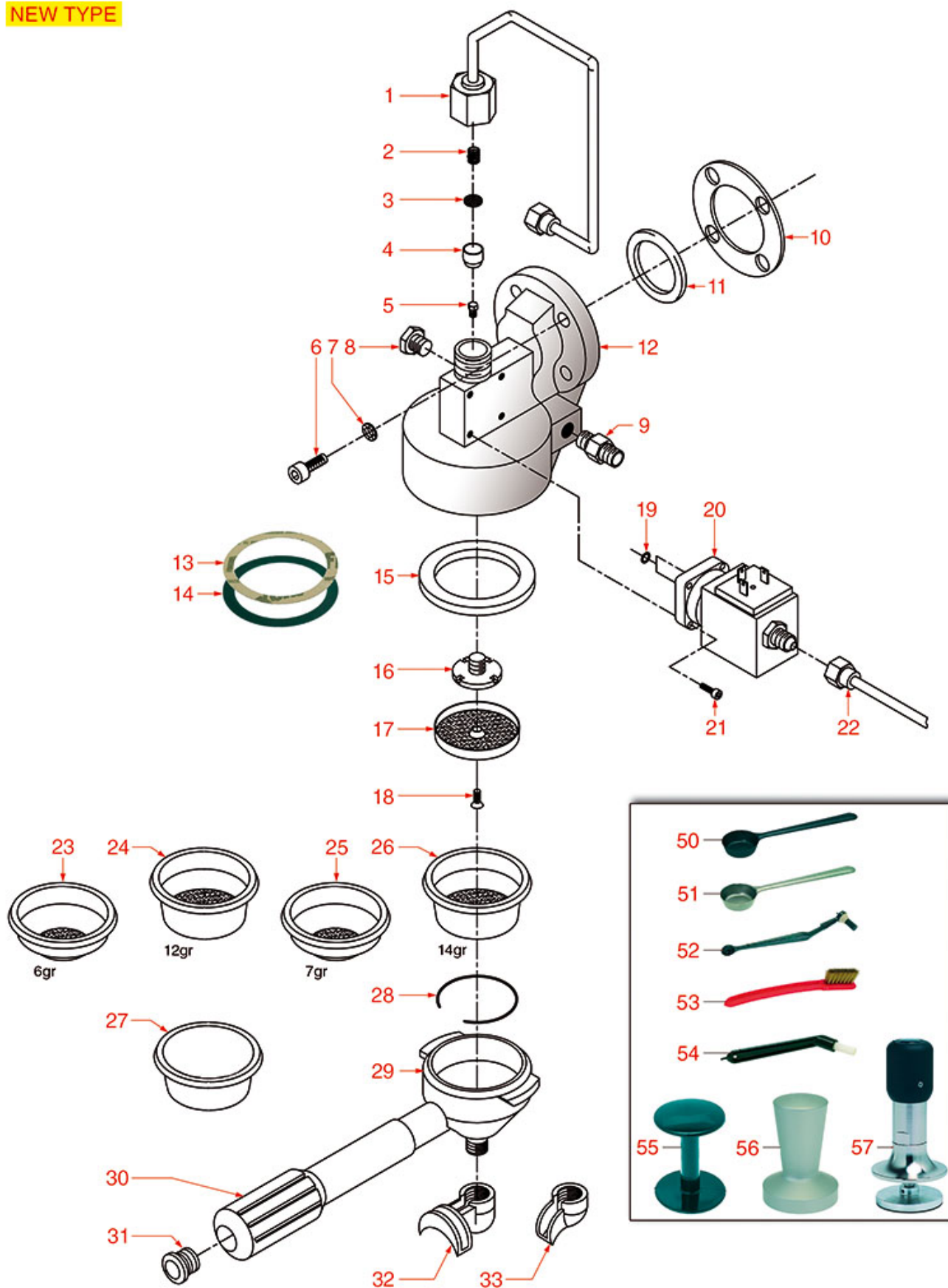

AU0201

Positions without LF code no.: upon request



BRUGNETTI-AURORA



Position	LF code no.	Description
3	1160516	WATER FILTER ø 11 mm
4	1160515	FILTER HOLDER BUSHING
5	1501541	NOZZLE M6x1 HOLE ø 0,8 mm
10	1186015	COFFEE GROUP GASKET ø 78x42x2 mm
10	1186098	COFFEE GROUP GASKET ø 78x43x2 mm
11	1186466	O-RING 03181 EPDM
13	1190011	PAPER SEAL ø 72x58x0.8 mm
14	1190003	RUBBER SHIM ø 70x57x1 mm EPDM
15	1186711	FILTER HOLDER GASKET ø 72x56x9 mm
16	1501014	BREW GROUP SPRAY NOZZLE ø 30 mm M9.6x1
17	1081026	SHOWER ø 56.5 mm
19	1186611	O-RING 02025 RED SILICONE
19	1186612	O-RING 02025 VITON
20	1120101	3-WAY SOLENOID VALVE PARKER 115V 50/60Hz
20	1120102	3-WAY SOLENOID VALVE LUCIFER 115V 60Hz
20	1120330	3-WAY SOLENOID VALVE LUCIFER 240V 50Hz
20	1120335	3-WAY SOLENOID VALVE PARKER 230V 50/60Hz
23	1160251	1 CUP FILTER 6 g ø 70x20.5 mm
24	1160252	FILTER 2-CUP 12 g ø 70x21 mm
25	1160335	1 CUP FILTER 7 g ø 70x24,5 mm
26	1160337	FILTER 2-CUP 14 g ø 70x24,5 mm
27	1160339	BLIND FILTER ø 70x17 mm
28	1250101	FILTER LOCKING SPRING ø 1,00 mm INOX
29	1165088	FILTER HOLDER FOR COFFEE MACHINES
30	1241169	FILTER HOLDER HANDLE M12
31	5051776	CAP CHROME PL. FOR FILTER HOLDER HANDLE
32	1022502	DOUBLE SPOUT ø 3/8"
33	1022501	SPOUT 1 CUP ø 3/8"
50	1069001	PLASTIC MEASURING SPOON 20 ml
51	1069002	STAINLESS STEEL MEASURING SPOON 20 ml
52	1384003	SHOWER CLEANING BRUSH BLACK
53	1384002	BRUSH FOR MAINTENANCE
54	1384001	SHOWER CLEANING BRUSH
55	1385002	NYLON COFFEE TAMPER ø 50/57 mm
56	1385053	ANODIZED ALUMINIUM TAMPER ø 58 mm
57	1385600	DYNAMOMETRIC MANUAL COFFEE TAMPER ø 57mm



TAPS AND LEVEL OLD TYPE

OLD TYPE

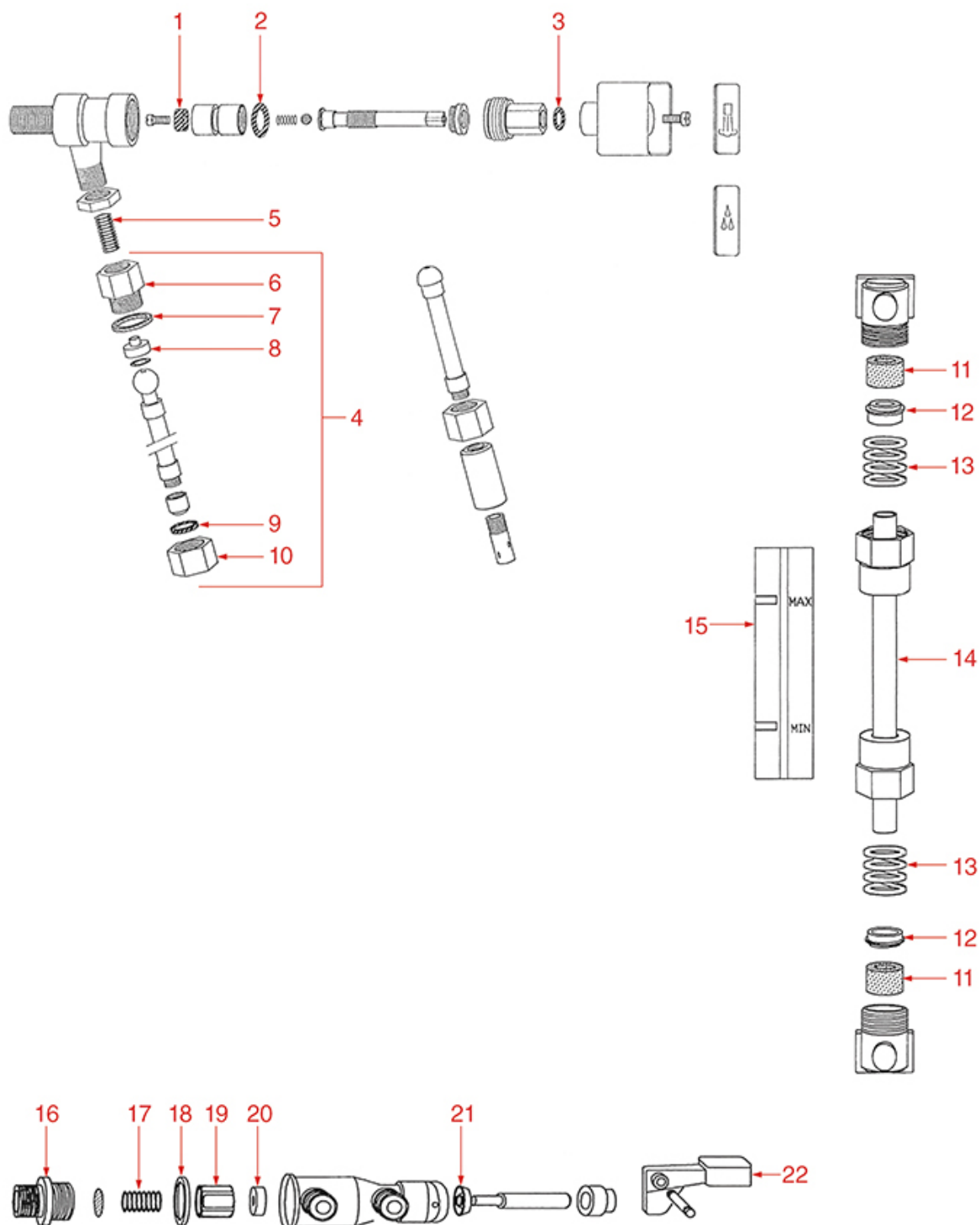



BRUGNETTI-AURORA



Position	LF code no.	Description
1	1186316	EPDM FLAT GASKET \varnothing 15x4x4 mm 60 SH
1	1186527	FLAT EPDM GASKET \varnothing 15x4x4 mm 80 SH
2	3243086	O-RING 0117 EPDM
3	1186236	O-RING 03043 VITON
4	1449326	STAINLESS STEEL STEAM PIPE COMPL. \varnothing 10 m
7	1186044	COPPER FLAT GASKET \varnothing 24x20x1 mm
9	1186318	O-RING 03043 EPDM
11	1186227	FLAT EPDM GASKET \varnothing 21x11.5x5 mm
12	1186090	LEVEL GLASS GASKET HOLDER
14	1520501	LEVEL GLASS \varnothing 12x175 mm
18	1186314	PTFE FLAT GASKET \varnothing 22x17x2 mm
20	1186316	EPDM FLAT GASKET \varnothing 15x4x4 mm 60 SH
20	1186527	FLAT EPDM GASKET \varnothing 15x4x4 mm 80 SH
21	1186091	LIP SEAL \varnothing 15x8x4 mm



MISCELLANEOUS

OLD TYPE

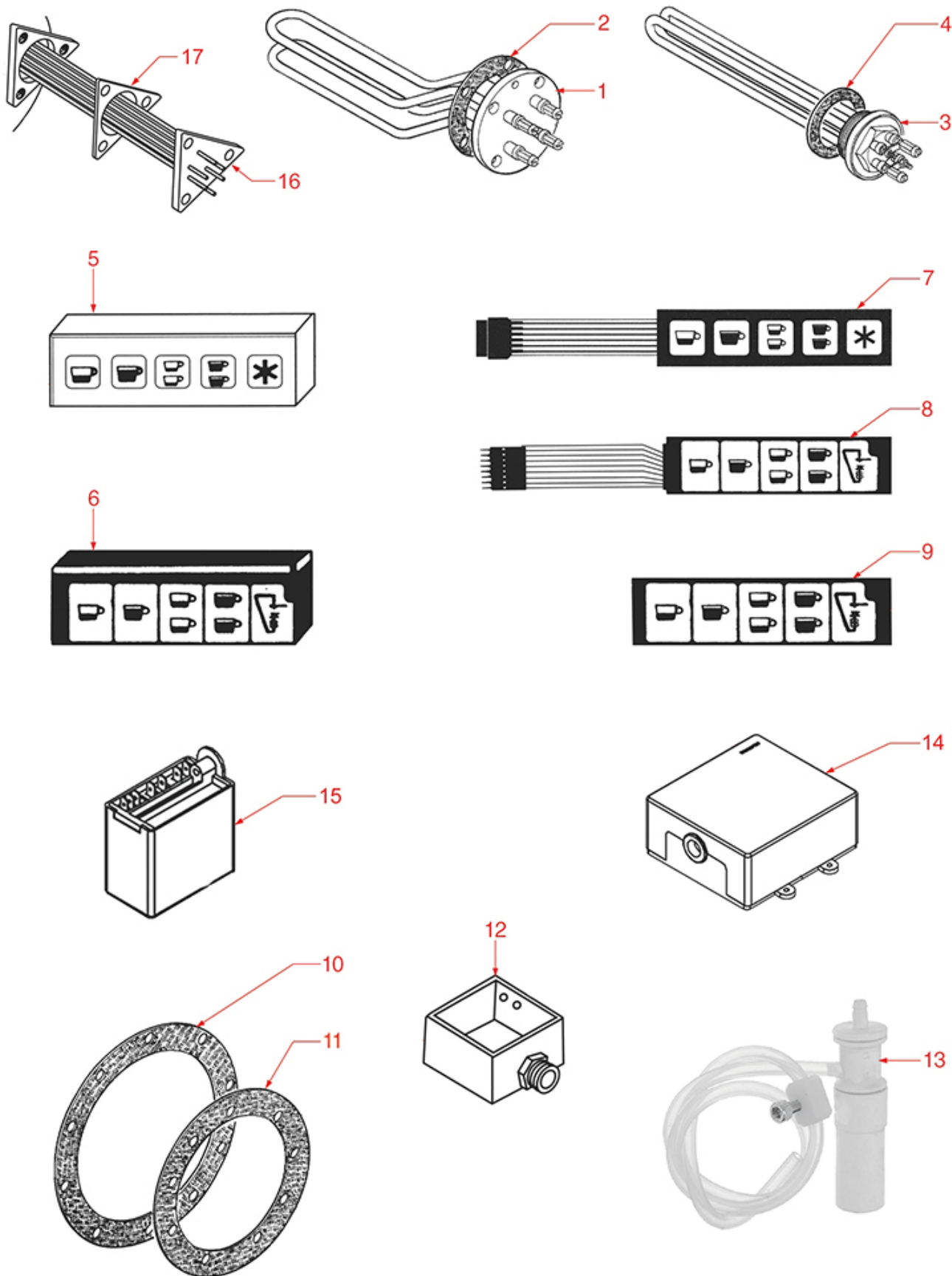

Positions without LF code no.: upon request



BRUGNETTI-AURORA



Position	LF code no.	Description
1	1755622	HEATING ELEMENT 2000W 220V
2	3186006	ASBESTOS FREE FLAT GASKET \varnothing 95x56x3 mm
3	1755026	HEATING ELEMENT 2000W 230V
3	1755134	HEATING ELEMENT 2400W 230V
4	1186623	PTFE FLAT GASKET \varnothing 53x43x3 mm
4	1186633	FLAT CARBO GASKET \varnothing 53x42x3 mm
4	3186010	ASBESTOS FREE FLAT GASKET \varnothing 54x42x2 mm
7	1319545	PUSH-BUTTON PANEL MEMBRANE 5 BUTTONS
10	1186276	BOILER GASKET \varnothing 210x150x3 mm
12	1527030	DRAIN TANK
13	1079002	MILK FROTHER STANDARD NYLON
14	5048271	DOSING CONTROL BOX 2 GROUPS 230V
15	5033337	DOSING CONTROL BOX 2 GROUPS 230V
16	5032257	HEATING ELEMENT 3000W 230/400V
17	1186634	TRIANGULAR GASKET FOR HEATING ELEMENT



Suitable for:

BRUGNETTI-AURORA



Suitable for:

Boiler safety valves

1523538 BOILER EXHAUST VALVE \varnothing 1/4" M
made of brass
HNBR/PTFE sealing



BRUGNETTI-AURORA

1515110 BOILER VALVE \varnothing 1/2" M 1.8bar CE-PED
calibration pressure 1.8 bar
steam outlet capacity 6.3 Kg/h



BRUGNETTI-AURORA

1515100 BOILER VALVE \varnothing 3/8" M 1.8bar CE-PED
calibration pressure 1.8 bar
steam outlet capacity 6.3 Kg/h



BRUGNETTI-AURORA

1523534 EXHAUST VALVE \varnothing 1/4" M
stainless steel - new model
internal PTFE coating - or viton



BRUGNETTI-AURORA 000634

1523537 EXHAUST VALVE \varnothing 1/4" M
stainless steel - old model
or viton



BRUGNETTI-AURORA

Brushes

1384023 BRUSH FOR CLEANING 50 mm



BRUGNETTI-AURORA

1384002 BRUSH FOR MAINTENANCE



BRUGNETTI-AURORA

1384001 SHOWER CLEANING BRUSH
100% made in Italy



BRUGNETTI-AURORA

1384014 SHOWER CLEANING BRUSH RED



BRUGNETTI-AURORA

Cappuccino makers - Cappuccinatore

1079002 MILK FROTHER STANDARD NYLON



BRUGNETTI-AURORA LAV2012

Coffee filters

1160339 BLIND FILTER \varnothing 70x17 mm
edge \varnothing 70 mm - height 17 mm



BRUGNETTI-AURORA 000034

1460067 FILER 2 CUPS 12 gr \varnothing 70x21 mm
border \varnothing 70 mm - height 21 mm
made in China



BRUGNETTI-AURORA 000033.2

5064969 FILTER CAPSULES EP-FAP SUPER CREAM
edge \varnothing 70 mm - body \varnothing 60 mm - height 75 mm
adapter for single dose capsules
complete with internal pressure valve
to make the product creamy
to be combined w. filter holder w/out sp. bottom
for the machine brand
suitable for machines BFC-BIANCHI-BRASILIA
BRUGNETTI AURORA-EXPOBAR-FAEMA-FIORENZATO CS
FUTURA-FUTURMAT-GRIMAC-ROYAL-SAB ITALIA-SANREMO
SCALA-VIBIEMME-WEGA



BRUGNETTI-AURORA

5108084 FILTER 1 CUP 6 g \varnothing 70x20.5 mm
border \varnothing 70 mm - height 20.5 mm
made in China



BRUGNETTI-AURORA 000033.1

1460065 FILTER 1 CUP 7 g \varnothing 70x24.5 mm
edge \varnothing 70 mm - h 24.5 mm
made in China



BRUGNETTI-AURORA

1460066 FILTER 2 CUPS 14 g \varnothing 70x24.5 mm
edge \varnothing 70 mm - h 24.5 mm
made in China



BRUGNETTI-AURORA



BRUGNETTI-AURORA



Suitable for:

1160252 FILTER 2-CUP 12 g ø 70x21 mm
edge ø 70 mm - height 21 mm



BRUGNETTI-AURORA 000033.2

Suitable for:

1160282 FILTER 2-CUP 14 g - COST EFFECTIVE
edge ø 70 mm - height 25 mm



BRUGNETTI-AURORA

1160337 FILTER 2-CUP 14 g ø 70x24,5 mm
edge ø 70 mm - height 24.5 mm



BRUGNETTI-AURORA

1460048 FILTRO CAPSULE EP-FAP SUPER EMULSION
edge ø 70 mm - body ø 60 mm - height 80 mm
adapter for double dose capsules
complete with internal pressure valve
to make the product creamy
to be combined w. filter holder w/out sp. bottom
for the machine brand
suitable for machines BFC-BIANCHI-BRUGNETTI
EXPOBAR-FAEMA-FUTURMAT-GRIMAC-ROYAL-SAB ITALIA
SANREMO-SCALA-VIBIEMME-WEGA



BRUGNETTI-AURORA

1160251 1 CUP FILTER 6 g ø 70x20.5 mm
edge ø 70 mm - height 20.5 mm



BRUGNETTI-AURORA 000033.1

1160335 1 CUP FILTER 7 g ø 70x24,5 mm
edge ø 70 mm - height 24.5 mm



BRUGNETTI-AURORA

1160281 1-CUP FILTER 7 gr - BASIC QUALITY
edge ø 70 mm - height 24.5 mm



BRUGNETTI-AURORA

Coffee groups

1160515 FILTER HOLDER BUSHING
for brew group



BRUGNETTI-AURORA 000178

Coffee measuring spoons

1069001 PLASTIC MEASURING SPOON 20 ml
overall length 195 mm



BRUGNETTI-AURORA

1069002 STAINLESS STEEL MEASURING SPOON 20 ml
material stainless steel AISI304
overall length 195 mm



BRUGNETTI-AURORA

Coffee spouts

1022522 ADJUSTABLE LONG DOUBLE SPOUT \varnothing 3/8"



BRUGNETTI-AURORA

1022523 ADJUSTABLE SHORT DOUBLE SPOUT \varnothing 3/8"



BRUGNETTI-AURORA

1022502 DOUBLE SPOUT \varnothing 3/8"



BRUGNETTI-AURORA 000041

1022524 DOUBLE SPOUT \varnothing 3/8"



BRUGNETTI-AURORA

1022521 LONG DOUBLE SPOUT \varnothing 3/8"



BRUGNETTI-AURORA

1022501 SPOUT 1 CUP \varnothing 3/8"



BRUGNETTI-AURORA 000040

1022504 SPOUT 1 CUP CLOSED \varnothing 3/8"



BRUGNETTI-AURORA

1022503 SPOUT 1 CUP STRAIGHT \varnothing 3/8"



BRUGNETTI-AURORA 000040

1022551 TRIPLE SPOUT \varnothing 3/8"



BRUGNETTI-AURORA

5031337 1-CUP STRAIGHT SHORT SPOUT \varnothing 3/8"



BRUGNETTI-AURORA



Suitable for:

BRUGNETTI-AURORA



Suitable for:

Detergents

3092543 COFFEE CLEAN DETERGENT 570 g
detergent for COFFEE MACHINES
suitable for the cleaning of filter holders
for grease and coffee stains on sauser and cups



BRUGNETTI-AURORA

3092355 DETERGENT CAPPUCCINO PERFECT 1 L
to clean milk frothers
please see the attached documentation for use



BRUGNETTI-AURORA

3092351 DETERGENT COFFEE CLEAN
package with 15 bags 20 g
for coffee groups cleaning



BRUGNETTI-AURORA

3092350 DETERGENT COFFEE CLEAN TABLET 2.5 g
jar with 60 tablets 2.5 g
for coffee groups cleaning



BRUGNETTI-AURORA

3092143 DETERGENT COFFEE CLEAN 900 g
detergent for COFFEE MACHINES
suitable for cleaning filters and filter holders
for grease and coffee stains on cups and saucers
please see the attached documentation for use



BRUGNETTI-AURORA

3092353 SCALE REMOVER SCALE CLEAN
package with 12 bags 25 g
for the cleaning of BABY coffee machines
please see the attached documentation for use



BRUGNETTI-AURORA

3092352 SCALE REMOVER SCALE CLEAN 1 kg
acid descaler for aluminium surfaces
copper, brass, iron



BRUGNETTI-AURORA

Drain hoses

1449270 DRAIN HOSE ELISPIR ø 12x18 mm - 30 m
alimentary



BRUGNETTI-AURORA

1449670 DRAIN HOSE ELISPIR ø 12x18 mm - 5 m
alimentary



BRUGNETTI-AURORA



Suitable for:

1449271 DRAIN HOSE ELISPIR \varnothing 14x20 mm - 30 m
alimentary



BRUNETTI-AURORA

Suitable for:

1449671 DRAIN HOSE ELISPIR \varnothing 14x20 mm - 5 m
alimentary



BRUNETTI-AURORA

1449272 DRAIN HOSE ELISPIR \varnothing 16x23 mm - 30 m
alimentary



BRUNETTI-AURORA

1449672 DRAIN HOSE ELISPIR \varnothing 16x23 mm - 5 m
alimentary



BRUNETTI-AURORA

1449273 DRAIN HOSE ELISPIR \varnothing 18x25 mm - 30 m
alimentary



BRUNETTI-AURORA

1449673 DRAIN HOSE ELISPIR \varnothing 18x25 mm - 5 m
alimentary



BRUNETTI-AURORA

1449274 DRAIN HOSE ELISPIR \varnothing 20x27 mm - 30 m
alimentary



BRUNETTI-AURORA

1449674 DRAIN HOSE ELISPIR \varnothing 20x27 mm - 5 m
alimentary



BRUNETTI-AURORA

1449255 DRAIN HOSE ELISPIR \varnothing 25x33 mm
sale per linear metre



BRUNETTI-AURORA

1449256 DRAIN HOSE ELISPIR \varnothing 30x38 mm
sale per linear metre



BRUNETTI-AURORA



Suitable for:

Suitable for:

Drain tanks

1527030 DRAIN TANK

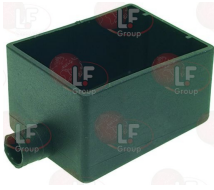

BRUGNETTI-AURORA 000353

Electronic boxes

5065886 CONTROL BOX DOSING 1 GROUP 230V
for Coffee machine (BRUGNETTI-AURORA) VIOLA



BRUGNETTI-AURORA 600.9.9.06.30 G

5033337 DOSING CONTROL BOX 2 GROUPS 230V
for Coffee machine (BRUGNETTI-AURORA) C



BRUGNETTI-AURORA 88.1.13.01

5048271 DOSING CONTROL BOX 2 GROUPS 230V
for Coffee machine (BRUGNETTI-AURORA) ALEXIA



BRUGNETTI-AURORA 550.9.5.25.02

Filter holder gaskets

1186711 FILTER HOLDER GASKET \varnothing 72x56x9 mm
4 external cuts
for Coffee machine (BRUGNETTI-AURORA) ALEXIA - C

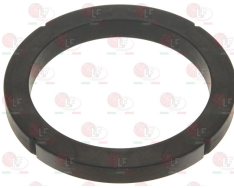

BRUGNETTI-AURORA 000177

Filter holder handles

5051776 CAP CHROME PL. FOR FILTER HOLDER HANDLE
mounting hole \varnothing 18 mm



BRUGNETTI-AURORA 000044.57

1241269 FILTER HOLDER HANDLE M10



BRUGNETTI-AURORA



BRUGNETTI-AURORA



Suitable for:

Suitable for:

1241502 FILTER HOLDER HANDLE M10

1241505 FILTER HOLDER HANDLE M10



BRUGNETTI-AURORA

BRUGNETTI-AURORA

5054506 FILTER HOLDER HANDLE M10 RED POLISHED

1141006 FILTER HOLDER HANDLE M10 SOFT



BRUGNETTI-AURORA

BRUGNETTI-AURORA

1141004 FILTER HOLDER HANDLE M10 WALNUT WOOD

5083515 FILTER HOLDER HANDLE M10 WALNUT WOOD



BRUGNETTI-AURORA

BRUGNETTI-AURORA

1241067 FILTER HOLDER HANDLE M12

1241169 FILTER HOLDER HANDLE M12



BRUGNETTI-AURORA 000043

BRUGNETTI-AURORA 000043.57

1241501 FILTER HOLDER HANDLE M12

1241504 FILTER HOLDER HANDLE M12



BRUGNETTI-AURORA

BRUGNETTI-AURORA

5054505 FILTER HOLDER HANDLE M12 RED POLISHED

1141003 FILTER HOLDER HANDLE M12 WALNUT WOOD



BRUGNETTI-AURORA

BRUGNETTI-AURORA



BRUGNETTI-AURORA



Suitable for:

5055983 FILTER HOLDER HANDLE M12 WALNUT WOOD



BRUGNETTI-AURORA

5051751 FILTER HOLDER HANDLE WHITE M10



BRUGNETTI-AURORA

Suitable for:

1141007 FILTER HOLDER HANDLE M124 SOFT



BRUGNETTI-AURORA

5051102 FILTER HOLDER HANDLE WHITE M12



BRUGNETTI-AURORA

Filter holder springs

1250333 FILTER LOCKING SPRING \varnothing 1.30 mm ST.STEEL



BRUGNETTI-AURORA

1250101 FILTER LOCKING SPRING \varnothing 1,00 mm INOX



BRUGNETTI-AURORA

BRUGNETTI-AURORA 000724

1250338 FILTER LOCKING SPRING \varnothing 1.40 mm ST.STEEL



BRUGNETTI-AURORA

1250002 S/STEEL FILTER LOCKING SPRING \varnothing 1.20 mm



BRUGNETTI-AURORA

Filter holders for coffee machines

1165162 BARLEY/COFFEE PODS FILTER HOLDER
wings 6.5 mm



BRUGNETTI-AURORA

5085669 BOTTOMLESS FILTER HOLDER DIFF. BRANDS
wings 7.2 mm
suitable for machines BRASILIA
suitable for machines BRUGNETTI-AURORA
suitable for machines CASADIO
suitable for machines ECM
suitable for machines FAEMA
suitable for machines FUTURMAT-ARIETE
suitable for machines GRIMAC



BRUGNETTI-AURORA



BRUGNETTI-AURORA



Suitable for:

1165183 BOTTOMLESS FILTER HOLDER FAEMA
wings 7.2 mm



BRUGNETTI-AURORA

Suitable for:

5083605 FILTER HOLDER CAPS. LAVAZZA DIFF. BRANDS
wings 7.2 mm
for single capsules lavazza blue



BRUGNETTI-AURORA

1165252 FILTER HOLDER F/COFFEE MACHINES NANOTECH
spout fitting \varnothing 3/8" - handle fitting M12
wings 6,6 mm
non-stick coating made of NANOQUARTZ
increases the resistance to corrosion
and to chemical reaction.
Thanks to the internal and external covering
the surfaces are completely non-stick,
the water flow is constant and uniform.
food-safe certified
suitable for machines VICTORIA ARDUINO



BRUGNETTI-AURORA

1165022 FILTER HOLDER FOR COFFEE MACHINES
spout connection \varnothing 3/8" - handle connection M12
wings 7 mm
for Coffee machine (BRUGNETTI-AURORA)



BRUGNETTI-AURORA 000047

1165088 FILTER HOLDER FOR COFFEE MACHINES
spout connection \varnothing 3/8" - knob connection M12
blades 6.6 mm



BRUGNETTI-AURORA 000047.57

Filters

1160516 WATER FILTER \varnothing 11 mm

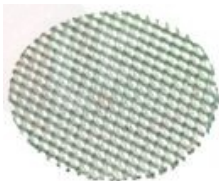

BRUGNETTI-AURORA 000179



Suitable for:

Suitable for:

Flowmeters

1455033 CONNECTOR FEMALE SMALL
for volumetric flowmeter



BRUGNETTI-AURORA

3455333 COVER-HEAD FOR VOLUMETRIC FLOW METER LED



BRUGNETTI-AURORA

1455032 IMPELLER GICAR



BRUGNETTI-AURORA

1455067 VOLUMETRIC FLOW METER GICAR
connections \varnothing 1/4"FF - orifice 1.15 mm - NSF

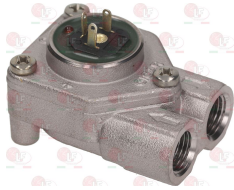

BRUGNETTI-AURORA 000601

1455033 CONNECTOR FEMALE SMALL
for volumetric flowmeter



BRUGNETTI-AURORA

3455333 COVER-HEAD FOR VOLUMETRIC FLOW METER LED



BRUGNETTI-AURORA

1455032 IMPELLER GICAR



BRUGNETTI-AURORA

1186631 O-RING 02112 VITON
ring thickness 1.78 mm - internal \varnothing 28.30 mm



BRUGNETTI-AURORA

Gaskets and seals

3186138 ASBESTOS FREE FLAT GASKET \varnothing 30x21x2 mm



BRUGNETTI-AURORA

3186010 ASBESTOS FREE FLAT GASKET \varnothing 54x42x2 mm



BRUGNETTI-AURORA 000306A

BRUGNETTI-AURORA 000308.A

3186006 ASBESTOS FREE FLAT GASKET \varnothing 95x56x3 mm
for heating element

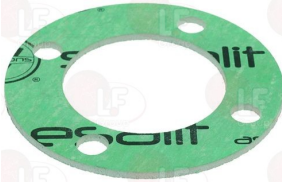

BRUGNETTI-AURORA 000306.A

BRUGNETTI-AURORA 000308A

1186619 COPPER FLAT GASKET \varnothing 18x14x1.5 mm



BRUGNETTI-AURORA

1186620 COPPER FLAT GASKET \varnothing 22x17x1.5 mm



BRUGNETTI-AURORA

1186044 COPPER FLAT GASKET \varnothing 24x20x1 mm



BRUGNETTI-AURORA 000219

1186823 COPPER FLAT GASKET \varnothing 27x21.5x1 mm



BRUGNETTI-AURORA

1186316 EPDM FLAT GASKET \varnothing 15x4x4 mm 60 SH

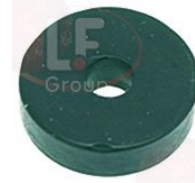

BRUGNETTI-AURORA 000213

1186633 FLAT CARBO GASKET \varnothing 53x42x3 mm
universal carbo
for heating element



BRUGNETTI-AURORA

1186527 FLAT EPDM GASKET \varnothing 15x4x4 mm 80 SH

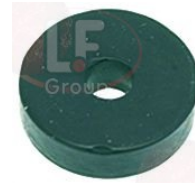

BRUGNETTI-AURORA 000213

1186314 PTFE FLAT GASKET \varnothing 22x17x2 mm



BRUGNETTI-AURORA 000466

BRUGNETTI-AURORA 000501

1186323 PTFE FLAT GASKET \varnothing 24x18x2 mm



BRUGNETTI-AURORA 000049



Suitable for:

1186623 PTFE FLAT GASKET \varnothing 53x43x3 mm
for heating element



BRUGNETTI-AURORA

Suitable for:

1186179 PTFE FLAT GASKET \varnothing 57x43x3 mm
for heating element

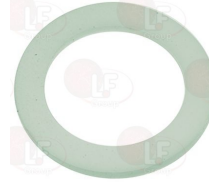

BRUGNETTI-AURORA

1186538 TRIANGULAR GASKET FOR HEATING ELEMENT
free of asbestos
dimensions 80x80x2 mm - internal hole 40 mm

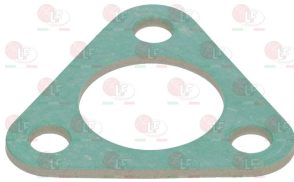

BRUGNETTI-AURORA

1186621 TRIANGULAR GASKET FOR HEATING ELEMENT
universal carbo
dimensions 80x80x3 mm - internal hole 40 mm
fastening holes mounting distance 57 mm



BRUGNETTI-AURORA

1186634 TRIANGULAR GASKET FOR HEATING ELEMENT
PTFE
dimensions 80x80x3 mm - internal hole \varnothing 40 mm
distance between the holes 58 mm

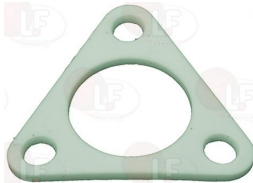

BRUGNETTI-AURORA 000308.F

Gaskets for coffee group

1186015 COFFEE GROUP GASKET \varnothing 78x42x2 mm
free of asbestos
for Coffee machine (BRUGNETTI-AURORA) ALEXIA - C

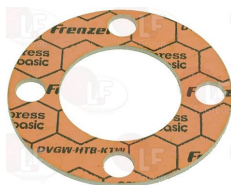

BRUGNETTI-AURORA 000460

1186098 COFFEE GROUP GASKET \varnothing 78x43x2 mm
universal carbo
for Coffee machine (BRUGNETTI-AURORA) ALEXIA - C



BRUGNETTI-AURORA 000460

Gaskets for coffee machine boiler

1186276 BOILER GASKET \varnothing 210x150x3 mm
universal carbo - 10 holes

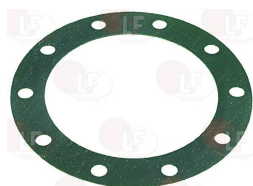

BRUGNETTI-AURORA 000458A

Heating elements

1755322 HEATING ELEMENT 1500W 230V
 immersed depth 145 mm - 4 poles
 fitting \varnothing 1"1/4



BRUNETTI-AURORA

1755622 HEATING ELEMENT 2000W 220V
 immersed length 230 mm - 4 poles
 distance between the holes 54 mm
 flange \varnothing 90 mm
 for coffee machines with 1 group



BRUNETTI-AURORA 000644

3186006 ASBESTOS FREE FLAT GASKET \varnothing 95x56x3 mm
 for heating element



BRUNETTI-AURORA 000306.A

BRUNETTI-AURORA 000308.A

1755026 HEATING ELEMENT 2000W 230V
 immersed length 175 mm - 2 poles
 connection \varnothing 1"1/4
 for coffee machines with 1 group



BRUNETTI-AURORA 000303

3186010 ASBESTOS FREE FLAT GASKET \varnothing 54x42x2 mm



BRUNETTI-AURORA 000306.A

BRUNETTI-AURORA 000308.A

1186633 FLAT CARBO GASKET \varnothing 53x42x3 mm
 universal carbo
 for heating element



BRUNETTI-AURORA

1186179 PTFE FLAT GASKET \varnothing 57x43x3 mm
 for heating element

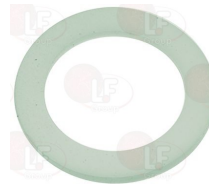

BRUNETTI-AURORA



BRUGNETTI-AURORA



Suitable for:

Suitable for:

1755134 HEATING ELEMENT 2400W 230V
immersed length 240 mm - 4 poles
connection \varnothing 1"1/4
for 2 groups coffee machines

3186010 ASBESTOS FREE FLAT GASKET \varnothing 54x42x2 mm



BRUGNETTI-AURORA 000304

BRUGNETTI-AURORA 000306A BRUGNETTI-AURORA 000308.A

1186633 FLAT CARBO GASKET \varnothing 53x42x3 mm
universal carbo
for heating element

1186623 PTFE FLAT GASKET \varnothing 53x43x3 mm
for heating element

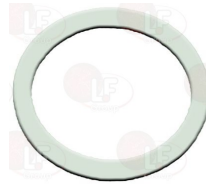

BRUGNETTI-AURORA

BRUGNETTI-AURORA

5032257 HEATING ELEMENT 3000W 230/400V
immersed length 305 mm - 6 poles
distance between fixing holes 58 mm
with bulb holder - flange 77x77 mm
for 2 group coffee machines
for Coffee machine (BRUGNETTI-AURORA) ALEXIA - C

1186538 TRIANGULAR GASKET FOR HEATING ELEMENT
free of asbestos
dimensions 80x80x2 mm - internal hole 40 mm

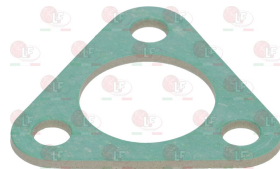

BRUGNETTI-AURORA 000645.F

BRUGNETTI-AURORA

1186621 TRIANGULAR GASKET FOR HEATING ELEMENT
universal carbo
dimensions 80x80x3 mm - internal hole 40 mm
fastening holes mounting distance 57 mm

1186634 TRIANGULAR GASKET FOR HEATING ELEMENT
PTFE
dimensions 80x80x3 mm - internal hole \varnothing 40 mm
distance between the holes 58 mm



BRUGNETTI-AURORA

BRUGNETTI-AURORA 000308.F

Ironmongery (screws,nuts,washers)

1455034 CYLINDER HEAD SCREW M4x10
stainless steel - with hexagon socket
UNI 5931 - DIN 912 - ISO 4762



BRUGNETTI-AURORA 02.2101.04.10

5057054 CYLINDER HEAD SCREW M6x16
stainless steel - with hexagon socket
UNI 5931 - DIN 912 - ISO 4762



BRUGNETTI-AURORA 02.2102.06.16

3528088 HEXAGON HEAD SCREW M8x20
stainless steel - UNI 5739 - DIN 933 - ISO 4017



BRUGNETTI-AURORA 02.2100.08.20

Knobs

1241227 STEAM CAP FOR KNOB
PACT



BRUGNETTI-AURORA

1241228 WATER CAP FOR KNOB
ACT



BRUGNETTI-AURORA

1241386 WATER/STEAM TAP KNOB
fine thread
for Coffee machine (BRUGNETTI-AURORA) C



BRUGNETTI-AURORA 000222

Level gauges

1520501 LEVEL GLASS \varnothing 12x175 mm



BRUGNETTI-AURORA 000319

1186090 LEVEL GLASS GASKET HOLDER



BRUGNETTI-AURORA 000506



Suitable for:

Suitable for:

Level probes

1341751 LEVEL PROBE \varnothing 1/4" M-150 mm
for Coffee machine (BRUGNETTI-AURORA) ALEXIA - C



BRUGNETTI-AURORA 000436

Lip seals

1186091 LIP SEAL \varnothing 15x8x4 mm



BRUGNETTI-AURORA 000497

1186095 LIP SEAL \varnothing 15x9x5 mm



BRUGNETTI-AURORA

1186816 LIP SEAL \varnothing 50x38x7.5 mm



BRUGNETTI-AURORA

1186817 LIP SEAL \varnothing 51x38x7.5 mm



BRUGNETTI-AURORA

Nozzles

1501541 NOZZLE M6x1 HOLE \varnothing 0,8 mm
for brew group
for Coffee machine (BRUGNETTI-AURORA) ALEXIA - C



BRUGNETTI-AURORA 000184

Nozzles for coffee groups

1501014 BREW GROUP SPRAY NOZZLE \varnothing 30 mm M9.6x1
hole M5
for Coffee machine (BRUGNETTI-AURORA) ALEXIA - C



BRUGNETTI-AURORA 000183

O-Ring and ORM gaskets

3060608 O-RING O3050 EPDM
ring thickness 2.62 mm - internal \varnothing 12.37 mm



BRUNETTI-AURORA

1186805 O-RING 0115 EPDM
ring thickness 2.62 mm - internal \varnothing 11.91 mm



BRUNETTI-AURORA

3243086 O-RING 0117 EPDM
ring thickness 2.62 mm - internal \varnothing 13.10 mm



BRUNETTI-AURORA 000215

1186611 O-RING 02025 RED SILICONE
ring thickness 1.78 mm - internal \varnothing 6.07 mm



BRUNETTI-AURORA 07.0610.05.80

1186612 O-RING 02025 VITON
ring thickness 1.78 mm - internal \varnothing 6.07 mm



BRUNETTI-AURORA

1186717 O-RING 02031 VITON
ring thickness 1.78 mm - internal \varnothing 7.66 mm



BRUNETTI-AURORA 09.0059

1186631 O-RING 02112 VITON
ring thickness 1.78 mm - internal \varnothing 28.30 mm



BRUNETTI-AURORA

1186318 O-RING 03043 EPDM
ring thickness 2.62 mm - internal \varnothing 10.78 mm



BRUNETTI-AURORA

1186236 O-RING 03043 VITON
ring thickness 2.62 mm - internal \varnothing 10.78 mm



BRUNETTI-AURORA 07.0610.08.30

1186466 O-RING 03181 EPDM
ring thickness 2.62 mm - internal \varnothing 45.69 mm
for group flange



BRUNETTI-AURORA 000962



Suitable for:

Suitable for:

Paper seals

1190011 PAPER SEAL \varnothing 72x58x0.8 mm



BRUGNETTI-AURORA 000177.S

Pressure gauges

1245507 **BOILER PRESSURE GAUGE \varnothing 52 mm 0÷3 bar**
single scale 0÷3 bar - connection \varnothing 1/4"M
frame \varnothing 57 mm - case \varnothing 52 mm



BRUGNETTI-AURORA

1245502 **BOILER-PUMP PRESSURE GAUGE \varnothing 60 mm**
double scale 0÷2.5/0÷16 bar - connections \varnothing 1/8"M
rim \varnothing 65 mm - body \varnothing 60 mm



BRUGNETTI-AURORA

1245503 **BOILER-PUMP PRESSURE GAUGE \varnothing 60 mm**
double scale 0÷2.5/0÷15 bar - connections \varnothing 1/8"M
rim \varnothing 65 mm - body \varnothing 60 mm



BRUGNETTI-AURORA

1245504 **BOILER-PUMP PRESSURE GAUGE \varnothing 60 mm**
double scale 0÷2.5/0÷16 bar - fittings \varnothing 1/8"M
frame \varnothing 65 mm - case \varnothing 60 mm



BRUGNETTI-AURORA

1245532 **BOILER-PUMP PRESSURE GAUGE \varnothing 63 mm**
double scale 0÷2.5/0÷15 bar - connections \varnothing 1/8"M
rim \varnothing 70 mm - body \varnothing 63 mm



BRUGNETTI-AURORA

Pressure switches

1320533 MEMBRANE KIT FOR PRESSURE SWITCH
model P302-6 ø 55 mm

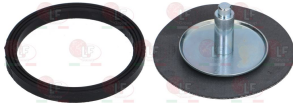

BRUGNETTI-AURORA

1320541 PRESSURE SWITCH PARKER 3-POLES 25A
CEI-UL approved
connection ø 1/4"
scale 0.5÷1.4 bar
differential 0.18÷0.03 bar
maximum pressure 2.1 bar
maximum temperature 140°C



BRUGNETTI-AURORA

1320531 PRESSURE SWITCH P302/6 3-POLES 30A
CE-SEV-ASE-UL approved
ISO 228 G connection 1/4" M for pipe ø 4x6 mm
adjustable scale 0.5÷1.4 bar
fixed differential 0.15 (± 0.06) bar
fluid temperature max : 140°C
max contact load : 220V 7KW (30A)
400V 12KW (30A)



BRUGNETTI-AURORA 000399

1320533 MEMBRANE KIT FOR PRESSURE SWITCH
model P302-6 ø 55 mm



BRUGNETTI-AURORA

Rotary vane pumps

1330101 ROTARY VANE PUMP ROTOFLOW ø 3/8" NPT
flange connection
flowrate 100 L/h
with balanced by-pass
fitting ø 3/8" conical NPT
NSF approved
model STANDARD
length without pin 82.5 mm
PUMP VERSION ECO-BRASS
made of BRASS CW510L (OT57)
low in lead <=0.25%

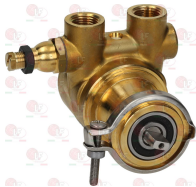

BRUGNETTI-AURORA

1330102 ROTARY VANE PUMP ROTOFLOW ø 3/8" NPT
flange connection
flowrate 200 L/h
with balanced by-pass
fitting ø 3/8" conical NPT
NSF approved
model STANDARD
length without pin 82.5 mm
PUMP VERSION ECO-BRASS
made of BRASS CW510L (OT57)
low in lead <=0.25%

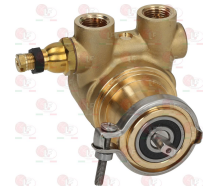

BRUGNETTI-AURORA



Suitable for:

1330040 VOLUMETRIC PUMP ODE \varnothing 3/8" GAS/BSP
 TECNOPOLIMER PPS body
 clamp connection
 flowrate 150 litri/h
 with balanced bypass
 fittings \varnothing 3/8" GAS/BSP st.steel
 NSF approved - FOOD-SAFE



BRUGNETTI-AURORA

Suitable for:

5109998 VOLUMETRIC PUMP ROTOFLOW \varnothing 3/8" GAS
 clamp fitting
 capacity 200 L/h
 with balanced by-pass
 fitting \varnothing 3/8" GAS/BSP
 NSF certified
 model STANDARD
 length without pin 82.5 mm
 VERSION OF THE PUMP ECO-BRASS
 made of brass CW510L (OT57)
 low in lead $\leq 0.25\%$

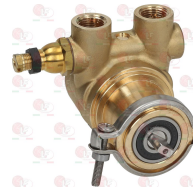

BRUGNETTI-AURORA

Rubberpieces for steam-water taps

1186339 BURN PREVENTING PIPE HANDGRIP \varnothing 8 mm



BRUGNETTI-AURORA

Seals for level glasses

1186227 FLAT EPDM GASKET \varnothing 21x11.5x5 mm
 for level glass

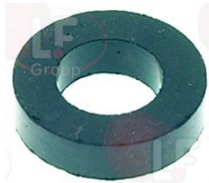

BRUGNETTI-AURORA 000464

Shower screens for brew group

1460204 PRECISION SHOWER SCREEN \varnothing 56.5 mm
 middle hole 6 mm - 98 holes \varnothing 3 mm
 Aisi 316 steel - food-safe certified
 integrated membrane 200 μ m
 suitable for machines BRUGNETTI AURORA
 NUOVA SIMONELLI-VICTORIA ARDUINO
 for Coffee machine (BRUGNETTI-AURORA)



BRUGNETTI-AURORA

1460209 PRECISION SHOWER SCREEN \varnothing 57.5 mm
 middle hole 6 mm - 112 holes \varnothing 2 mm
 Aisi 304 steel - food-safe certified
 wire membrane 35 μ m
 suitable for machines BRUGNETTI AURORA
 NUOVA SIMONELLI-VICTORIA ARDUINO
 for Coffee machine (BRUGNETTI-AURORA)



BRUGNETTI-AURORA



Suitable for:

1081603 PRECISION SHOWER SCREEN NANOTEC \varnothing 56.5mm

non-stick NANOQUARTZ coating
increases the resistance to corrosion
and to chemical reaction
middle hole 6 mm - 98 holes \varnothing 3 mm
Aisi 316 steel - food-safe certified
integrated membrane 200 μ m
suitable for machines BRUGNETTI AURORA
NUOVA SIMONELLI-VICTORIA ARDUINO



BRUGNETTI-AURORA

Suitable for:

1081026 SHOWER \varnothing 56.5 mm
for Coffee machine (BRUGNETTI-AURORA) ALEXIA - C



BRUGNETTI-AURORA 000182

1081130 SHOWER SCREEN \varnothing 56,5 mm
made in China



BRUGNETTI-AURORA 000182

1081003 SHOWER SCREEN \varnothing 57.5 mm



BRUGNETTI-AURORA

Solenoid valves

1120332 COIL LUCIFER/PARKER 220/240V 9W 50Hz

width 32 mm - height 38 mm
length 43 mm



BRUGNETTI-AURORA

3120032 COIL PARKER ZB09 9W 220/240V 50/60Hz

width 34 mm - height 33 mm
length 43 mm



BRUGNETTI-AURORA

3120034 CONNECTOR LARGE F-FITTING
for coils



BRUGNETTI-AURORA 000564

1120809 SOLENOID VALVE ODE 3 WAYS 230V 8W
RUBY seal - orifice \varnothing 1.5 mm
TAPERED fitting
with coil B0108223DS 220/230V 50/60Hz 8W
fluid temperature -40°C $+180^{\circ}\text{C}$



BRUGNETTI-AURORA



Suitable for:

Suitable for:

1120102 3-WAY SOLENOID VALVE LUCIFER 115V 60Hz
 E131F4304 - drain \varnothing 1/8" conical - max 10 bar
 RUBY seal - orifice \varnothing 1.5 mm
 with coil 483510S5 9W 110/115/120V 50/60Hz
 fluid temperature -40°C+140°C



BRUGNETTI-AURORA 000191.UL.110

1120330 3-WAY SOLENOID VALVE LUCIFER 240V 50Hz
 E131F4304 - drain \varnothing 1/8" conical - max 10 bar
 RUBY seal - orifice \varnothing 1.5 mm
 with coil 483510S6 9W 220/240V 50/60Hz
 fluid temperature -40°C+140°C



BRUGNETTI-AURORA 000191

1120332 COIL LUCIFER/PARKER 220/240V 9W 50Hz
 width 32 mm - height 38 mm
 length 43 mm



BRUGNETTI-AURORA

1120101 3-WAY SOLENOID VALVE PARKER 115V 50/60Hz
 VE128IR - drain \varnothing 1/8" conical - max 10 bar
 RUBY seal - orifice \varnothing 1.3 mm
 with coil ZB09 9W 110/120V 50/60Hz
 fluid temperature -40°C+140°C



BRUGNETTI-AURORA

1120335 3-WAY SOLENOID VALVE PARKER 230V 50/60Hz
 VE128IR - drain \varnothing 1/8" conical - max 10 bar
 RUBY seal - orifice \varnothing 1.3 mm
 with coil ZB09 9W 220/230V 50/60Hz
 fluid temperature -30°C+140°C



BRUGNETTI-AURORA

Steam-water pipes coffee machines

1449326 STAINLESS STEEL STEAM PIPE COMPL. \varnothing 10 m
 for Coffee machine (BRUGNETTI-AURORA) ALEXIA



BRUGNETTI-AURORA LAV2011

BRUGNETTI-AURORA 800202

BRUGNETTI-AURORA 800203

Switches

1319545 PUSH-BUTTON PANEL MEMBRANE 5 BUTTONS



BRUGNETTI-AURORA

Tampers for coffee

1385000 NYLON TAMPER \varnothing 50/52 mm



BRUGNETTI-AURORA 000447

Tools

1505002 EXTRACTOR FOR FILTER S.STEEL WITH HOLE



BRUGNETTI-AURORA

3394906 INSPECTION MIRROR KIT \varnothing 30x165 mm
telescopic - overall length 485 mm



BRUGNETTI-AURORA

Water softeners and spare parts

3010291 **MANUAL WATER SOFTENER 5 L \varnothing 3/8"**
for water treatment for TECHNICAL use
st/steel bottle capacity 5 L
fastening fitting 3/8"
dimensions: h 300 mm - \varnothing 190 mm
resin content 3.5 L
regeneration salt(NaCl-table salt)1 Kg



BRUGNETTI-AURORA

3010001 **MANUAL WATER SOFTENER 8 L \varnothing 3/8"**
for water treatment for TECHNICAL purposes
STAINLESS STEEL cylinder capacity 8 L
connection 3/8"
dimensions: height 400 mm - \varnothing 185 mm
resin content 5.8 L
regeneration salt(NaCl-table salt)1 Kg



BRUGNETTI-AURORA 000253



BRUGNETTI-AURORA



Suitable for:

Suitable for:

3010161 MANUAL WATER SOFTENER 8 L ø 3/8"
for water treatment for TECHNICAL purposes
plasma welding
STAINLESS STEEL cylinder capacity 8 L
connection 3/8"
dimensions: height 400 mm - ø 185 mm
resin content 5.8 L
regeneration salt(NaCl-table salt)1 Kg
inlet water maximum temperature 60°C

3010112 RESIN 5 L
5 litre bag



BRUGNETTI-AURORA

BRUGNETTI-AURORA

3010299 SALT FOR WATER SOFTNER IN TABLETS 10 Kg
FOR WATER SOFTENING SYSTEMS

3010300 SALT FOR WATER SOFTNER IN TABLETS 25 Kg
FOR WATER SOFTENING SYSTEMS



BRUGNETTI-AURORA

BRUGNETTI-AURORA

The data herewith contained may change without notice and LF SpA cannot be held responsible for possible errors stated or resulting by the use of this document. All rights reserved. No part of this publication may be reproduced without written permission by LF SpA.



Distributing Components, Spare Parts & Accessories in original quality worldwide

-
- LF SpA HEADQUARTERS**
via Voltri, 80 - 47522 Cesena (FC) ITALY
Tel. +39 0547 34 11 11 - Fax +39 0547 34 11 10
www.lfricambi724.it - info@lfricambi.it
Export Dept. Tel. +39 0547 34 11 50 - Fax +39 0547 34 11 55
www.lfspareparts724.com - export@lfspareparts.com
- LF SpA HOUSEHOLD COMPONENTS DIVISION**
Via Padriciano, 99 - AREA Science Park - 34149 Trieste (TS) ITALY
Tel. +39 0547 34 12 42 - Fax +39 0547 34 12 48
www.lfspareparts724.com - info@lfspareparts.com
- EPGC Sas FRANCE**
13, Rue des Forts - 59960 Neuville en Ferrain
Tel. +33 (0)3 20 25 06 21 - Fax +33 (0)3 20 25 34 12
www.epgc.com - epgc@epgc.com
- LF GmbH GERMANY**
Junkersstrasse, 3 - D-82178 Puchheim - München
Tel. +49 89 89 45 78 66 - Fax +49 89 89 45 78 88
www.lfersatzteile724.de - info@lfersatzteile.de
- LF China REPUBLIC OF CHINA**
Room 403, No.2, Huadu Mansion, Lane 422, Huanghua Rd.
Minhang Dist. - 201103 Shanghai
Tel. +86 (0)21 33 53 66 31 - Fax +86 (0)21 33 53 66 32
www.lfspareparts724.com - china@lfspareparts.com
- OOO LF RUSSIAN FEDERATION**
Ul. Anatoliya Zhivova, 8 - office 1 - 123100 Moscow
Tel./Fax +7 495 725 26 53
www.lfspareparts724.ru - info@lfspareparts.ru
- LF Repuestos Horeca S.L.U. SPAIN**
Poligono Industrial Carpetania - C/Miguel Faraday, 8 - 28906 Getafe
Tel. +34 91 477 91 00 - Fax +34 91 477 90 81
www.lfrepuestos-horeca724.es - info@lfrepuestos.es
- LF Scandinavia Aps - LF Spareparts S.p.A. DENMARK**
Nupark, 51 - 7500 Holstebro
Tel. +45 70 70 77 33
www.lfspareparts724.dk - denmark@lfspareparts.dk
- LF SpA Cesena (IT) Swiss Branch Steinhausen SWITZERLAND**
Sennweidstrasse, 45 - CH-6312 Steinhausen
Tel. +41 (0)41 760 15 80/1 - Fax +41 (0)41 760 15 85
www.lfersatzteile724.ch - info@lfersatzteile.ch
- LF Spare Parts Ltd. UNITED KINGDOM**
A10a Lakeside Business Park, Broadway Lane
South Cerney, Gloucestershire GL7 5XL
Tel. +44 (0)1285 86 16 25 - Fax +44 (0)1285 86 39 49
www.lfspareparts724.co.uk - info@lfspareparts.co.uk
- LF Central Est Europe S.r.o. CZECH REPUBLIC**
Antala Staska 1859/34
14000 Praha 4 - KRC
Tel. +420 730 156 910
www.lfspareparts724.cz - info@lfspareparts.cz
- LF SPARE PARTS INC. USA**
Legal address:
155 Office Plaza Dr - Suite A - Tallahassee, FL 32301
Business/Mailing address:
1100 South Tower, 225 Peachtree St., N.E. - Atlanta, GA 30303, USA
Tel. +1-404-525-2600 - Fax +1-404-586-3528
www.lfspareparts724.us - info@lfspareparts.us
Tel. West Coast and Midwest: 206-349-1525 Sauro
Tel. East Coast and the Caribbean: 786-817-1764 Luis
-
- AUSTRALIA AND NEW ZEALAND**
www.lfspareparts724.com
andrea.calvio@lfspareparts.com
- AUSTRIA**
www.lfersatzteile724.at
info@lfersatzteile.at
- BALKAN COUNTRIES**
www.lfspareparts724.com
matija.ramov@lfspareparts.com
- BALTIC COUNTRIES**
www.lfspareparts724.com
inara.silina@lfspareparts.com
- LATIN AMERICA AND THE CARRIBEANS**
www.lfrepuestos-horeca724.es
export@lfrepuestos.es
- POLAND**
www.lfspareparts724.pl
info@lfspareparts.pl
- SOUTH KOREA**
www.lfspareparts724.com
fabio.doni@lfspareparts.com
- TURKEY**
www.lfyedekparca724.com
export@lfspareparts.com